

M-Pulse Microwave

Silicon Bipolar MMIC Cascadable Amplifier

MP4TD0770

Features

- Cascadable 50Ω Gain Block
- Low Operating Voltage (4.0 V Typical Vd)
- 3dB Bandwidth: DC to 1.5 GHz
- 11.6 dB Typical Gain @ 1.0 GHz
- Unconditionally Stable ($k > 1$)
- Hermetic Gold-Ceramic Microstrip Package
- Tape and Reel Packaging Available

Description

M-Pulse's MP4TD0770 is a high performance silicon bipolar MMIC housed in a hermetic high reliability stripline package. The MP4TD0770 is useful where a general purpose 50Ω gain block with good noise figure is required. Typical applications include narrow and wide band IF and RF amplifiers in industrial and military applications.

The MP4TD0770 is fabricated using a 10 GHz f_T silicon bipolar technology that features gold metalization and IC passivation for increased performance and reliability.

Gold-Ceramic Microstrip Package Outline^{1,2}

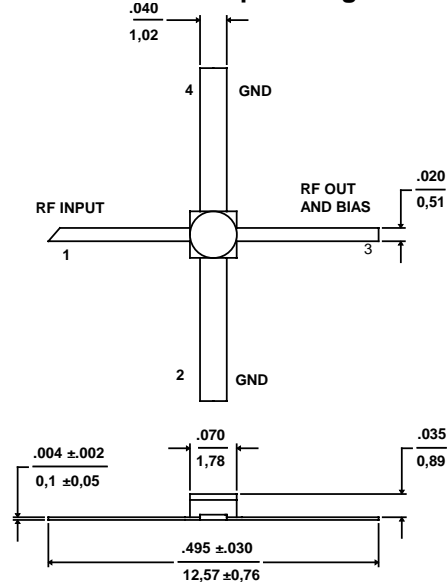

- Notes: (unless otherwise specified)
 1. Dimensions are in / mm
 2. Tolerance: in .xxx = ±.005; mm .xx = ±.13

TYPICAL POWER GAIN vs FREQUENCY

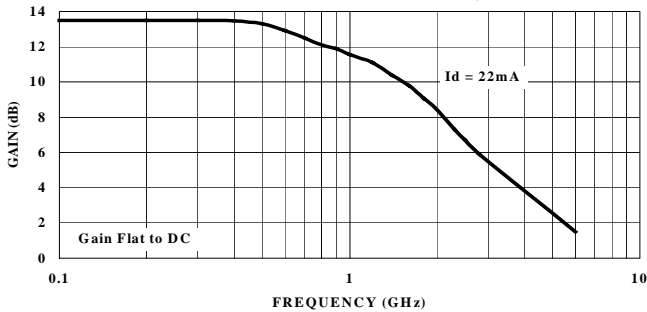

Pin Configuration

Pin Number	Pin Description
1	RF Input
2 & 4	AC/DC Ground
3	RF Output and DC Bias

Ordering Information

Model No.	Package
MP4TD0770	Hermetic Ceramic
MP4TD0770T	Tape and Reel

Electrical Specifications @ $T_A = +25^\circ\text{C}$, $I_d = 22\text{ mA}$, $Z_0 = 50\Omega$

Symbol	Parameters	Test Conditions	Units	Min.	Typ.	Max.
Gp	Power Gain ($ S_{21} ^2$)	f = 0.1 GHz	dB	12.5	13.5	14.5
ΔG_p	Gain Flatness	f = 0.1 to 1.0 GHz	dB	-	±1.0	±1.2
$f_{3\text{dB}}$	3 dB Bandwidth	-	GHz	-	1.5	-
SWR _{in}	Input SWR	f = 0.1 to 1.5 GHz	-	-	1.5	-
SWR _{out}	Output SWR	f = 0.1 to 1.5 GHz	-	-	1.3	-
P _{1dB}	Output Power @ 1 dB Gain Compression	f = 1.0 GHz	dBm	-	6.0	-
NF	50 Ω Noise Figure	f = 1.0 GHz	dB	-	4.5	-
IP ₃	Third Order Intercept Point	f = 1.0 GHz	dBm	-	19.0	-
t _D	Group Delay	f = 1.0 GHz	ps	-	140	-
V _d	Device Voltage	-	V	3.6	4.0	4.4
dV/dT	Device Voltage Temperature Coefficient	-	mV/°C	-	-7.0	-

Specification Subject to Change Without Notice

Absolute Maximum Ratings¹

Parameter	Absolute Maximum
Device Current	60 mA
Power Dissipation ^{2,3}	275 mW
RF Input Power	+13 dBm
Junction Temperature	200°C
Storage Temperature	-65°C to +200°C

Thermal Resistance: $\theta_{jC} = 155 \text{ }^\circ\text{C/W}$

1. Exceeding these limits may cause permanent damage.
2. Case Temperature (T_c) = 25 °C.
3. Derate at 6.5 mW/°C for $T_c > 157^\circ\text{C}$.

Typical Bias Configuration

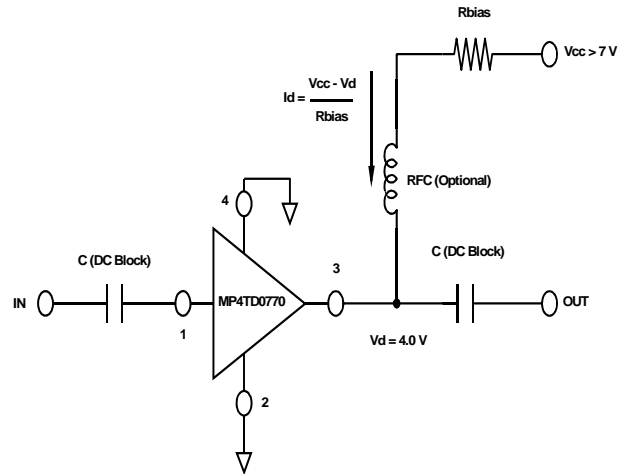

Typical Performance Curves @ $I_d = 22 \text{ mA}$, $T_A = +25^\circ\text{C}$ (unless otherwise noted)

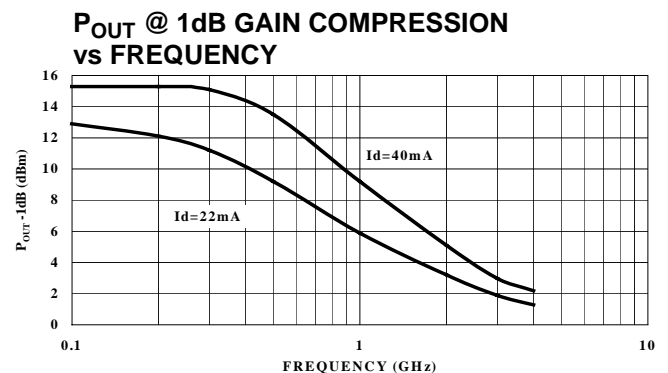
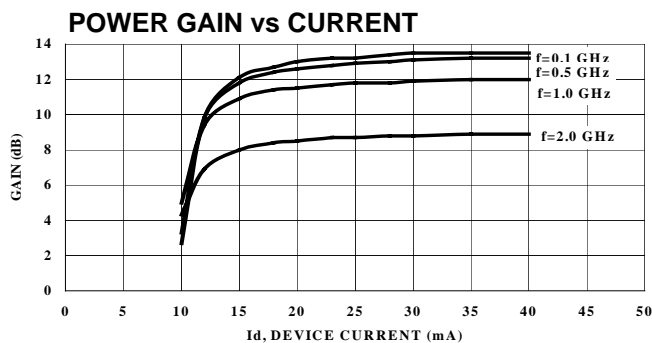
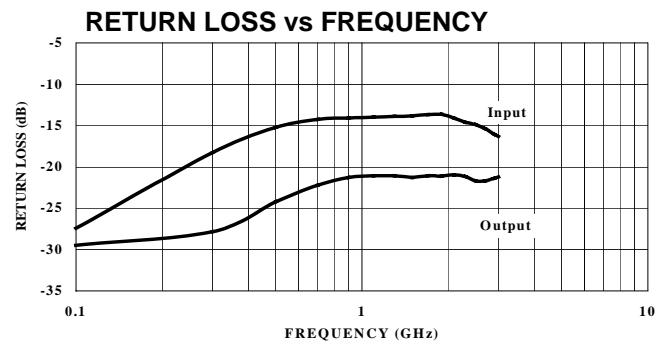
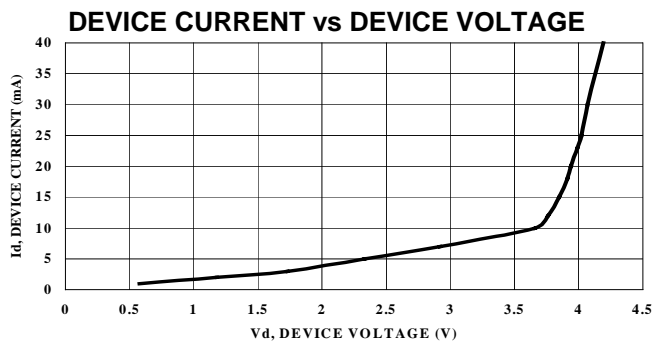

Specification Subject to Change Without Notice

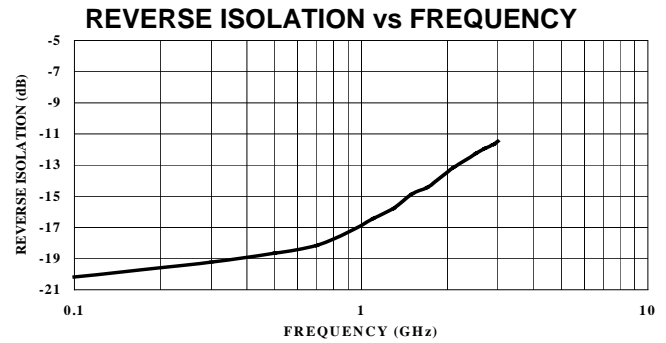
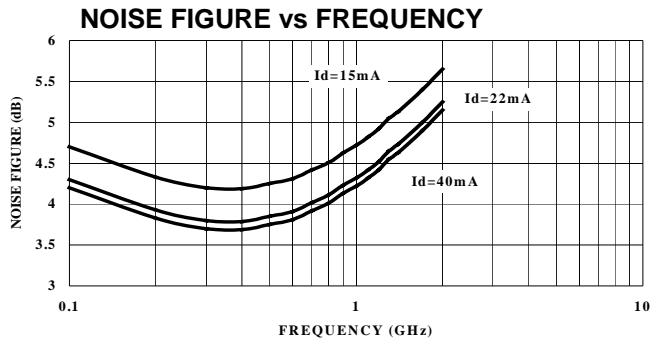

Typical Scattering Parameters

$Z_0 = 50\Omega$, $T_A = +25^\circ\text{C}$, $I_d = 22\text{mA}$

Frequency (GHz)	S11		S21		S12		S22	
	Mag.	Angle	Mag.	Angle	Mag.	Angle	Mag	Angle
0.1	0.42	96.5	4.73	171.5	0.098	9.3	0.033	-52.9
0.2	0.82	97.3	4.72	164.3	0.104	6.2	0.034	-56.2
0.4	0.153	107.3	4.70	150.9	0.116	15.6	0.051	-80.9
0.6	0.185	116.5	4.27	136.9	0.121	20.6	0.071	-103.6
0.8	0.198	128.5	4.03	122.4	0.132	25.7	0.083	-115.6
1.0	0.200	139.6	3.85	110.7	0.143	29.0	0.087	-123.9
1.5	0.203	165.4	3.24	86.3	0.180	34.7	0.086	-138.1
2.0	0.200	173.6	2.64	60.3	0.215	35.7	0.088	-150.0
2.5	0.180	174.2	2.16	46.9	0.243	33.0	0.082	-163.7
3.0	0.152	162.8	1.86	33.5	0.267	31.8	0.087	-163.6
3.5	0.123	144.0	1.69	20.5	0.296	30.3	0.119	-166.8
4.0	0.149	101.8	1.50	14.8	0.318	27.9	0.139	-171.4
4.5	0.250	84.1	1.45	4.7	0.355	25.8	0.183	-170.8
5.0	0.337	79.6	1.34	-2.9	0.389	21.7	0.229	-175.4
60	0.485	72.4	1.19	-12.9	0.456	16.5	0.272	178.3

Specification Subject to Change Without Notice