

M-Pulse Microwave

Silicon Bipolar MMIC Cascadable Amplifier

MP4TD0910

Features

- Cascadable 50Ω Gain Block
- 3dB Bandwidth: DC to 5.0 GHz
- 7.5 dB Typical Gain @ 1.0 GHz
- Input & Output SWR: <1.9 from 0.1 to 3.0 GHz
- Hermetic Gold-Ceramic Microstrip Package
- Tape and Reel Packaging Available

Description

M-Pulse's MP4TD0910 is a high performance silicon bipolar MMIC housed in a hermetic high reliability stripline package. The MP4TD0910 is designed for use where a general purpose broad band (4.5 GHz) 50Ω gain block is required. Typical applications include narrow and wide band IF and RF amplifiers in industrial and military applications.

The MP4TD0910 is fabricated using a 10 GHz f_T silicon bipolar technology that features gold metalization and IC passivation for increased performance and reliability.

Gold-Ceramic Microstrip Package Outline^{1,2}

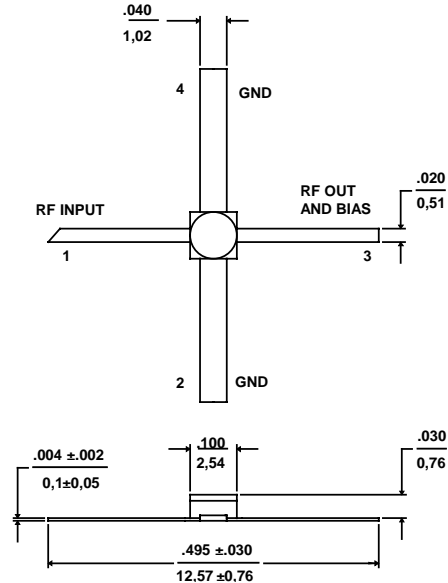

Notes: (unless otherwise specified)

1. Dimensions are in / mm
2. Tolerance: in .xxx = ±.005; mm .xx = ±.13

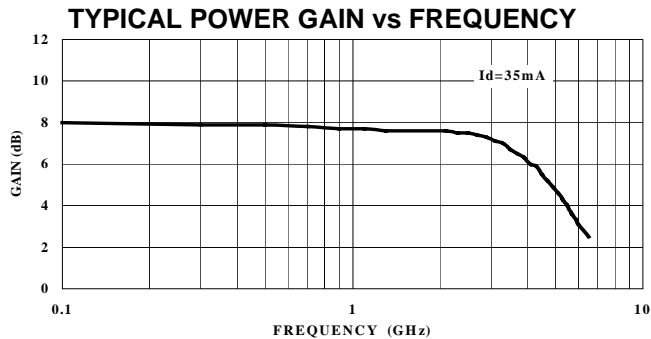

Pin Configuration

Pin Number	Pin Description
1	RF Input
2 & 4	AC/DC Ground
3	RF Output and DC Bias

Ordering Information

Model No.	Package
MP4TD0910	Ceramic
MP4TD0910T	Tape and Reel

Electrical Specifications @ $T_A = +25^\circ\text{C}$, $I_d = 35 \text{ mA}$, $Z_0 = 50\Omega$

Symbol	Parameters	Test Conditions	Units	Min.	Typ.	Max.
G_p	Power Gain ($ S_{21} ^2$)	$f = 0.1 \text{ GHz}$	dB	7.0	7.5	9.0
ΔG_p	Gain Flatness	$f = 0.1 \text{ to } 3.0 \text{ GHz}$	dB	-	±0.5	±0.7
$f_{3\text{dB}}$	3 dB Bandwidth	-	GHz	-	5.0	-
SWR_{in}	Input SWR	$f = 0.1 \text{ to } 3.0 \text{ GHz}$	-	-	1.9	-
SWR_{out}	Output SWR	$f = 0.1 \text{ to } 2.0 \text{ GHz}$	-	-	1.8	-
$P_{1\text{dB}}$	Output Power @ 1 dB Gain Compression	$f = 1.0 \text{ GHz}$	dBm	-	11.5	-
NF	50 Ω Noise Figure	$f = 1.0 \text{ GHz}$	dB	-	6.0	-
IP_3	Third Order Intercept Point	$f = 1.0 \text{ GHz}$	dBm	-	23.0	-
t_D	Group Delay	$f = 1.0 \text{ GHz}$	ps	-	100	-
V_d	Device Voltage	-	V	7.0	7.8	8.6
dV/dT	Device Voltage Temperature Coefficient	-	mV/°C	-	-16.0	-

Specification Subject to Change Without Notice

Absolute Maximum Ratings¹

Parameter	Absolute Maximum
Device Current	80 mA
Power Dissipation ^{2,3}	750 mW
RF Input Power	+20 dBm
Junction Temperature	200°C
Storage Temperature	-65°C to +150°C

Thermal Resistance: $\theta_{jC} = 145^{\circ}\text{C}/\text{W}$

1. Exceeding these limits may cause permanent damage.
2. Case Temperature (T_c) = 25 °C.
3. Derate at 6.9 mW/°C for $T_c > 91^{\circ}\text{C}$.

Typical Bias Configuration

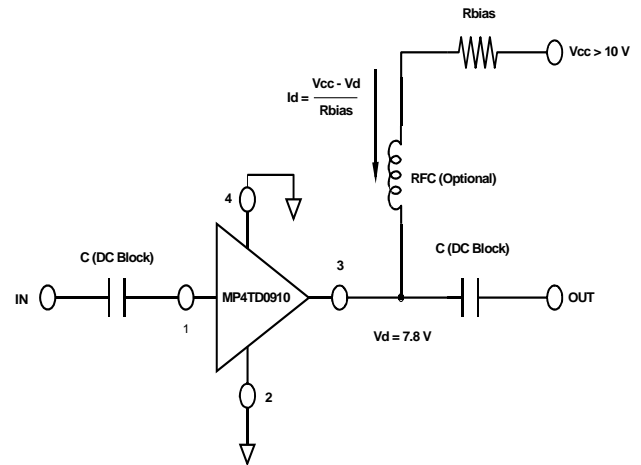

Typical Performance Curves @ $I_d = 35\text{ mA}$, $T_A = +25^{\circ}\text{C}$ (unless otherwise noted)

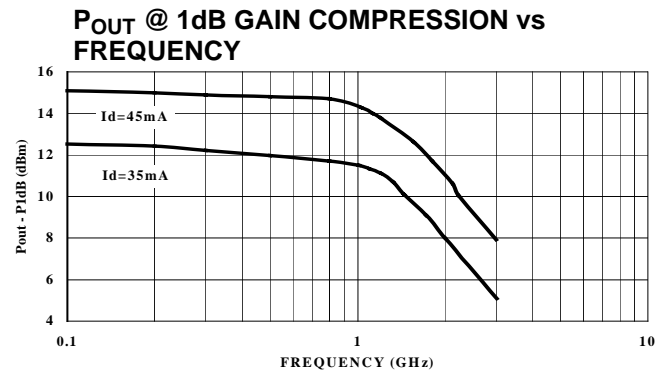
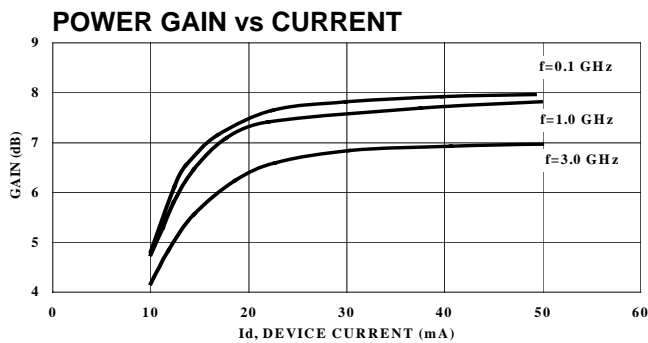
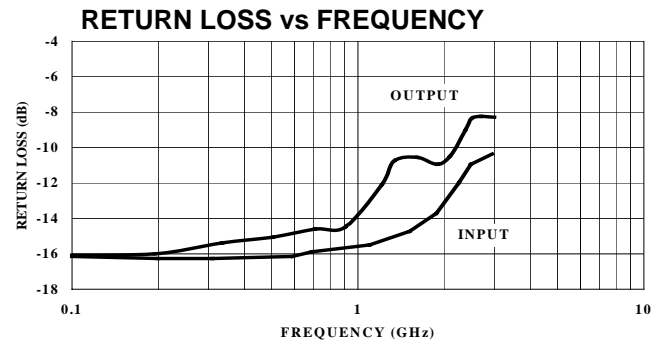
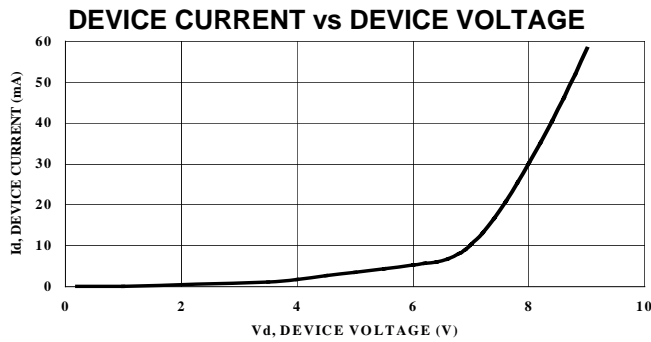

Specification Subject to Change Without Notice

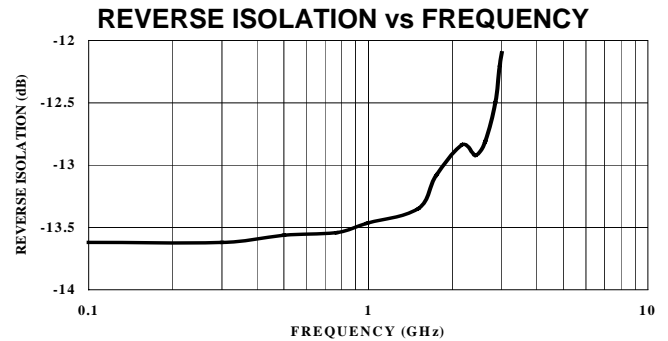
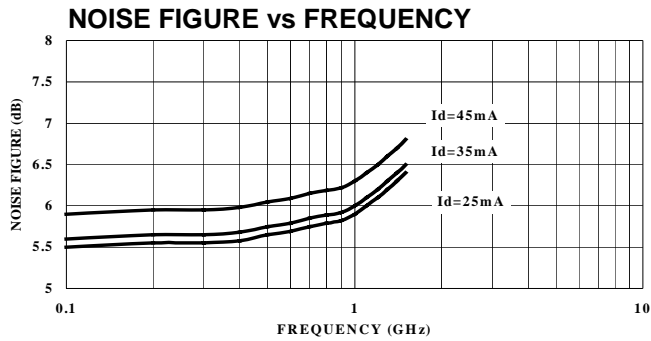

Typical Scattering Parameters

Z₀ = 50Ω, T_A = +25°C, I_d = 35 mA

Frequency (GHz)	S ₁₁		S ₂₁		S ₁₂		S ₂₂	
	Mag.	Angle	Mag.	Angle	Mag.	Angle	Mag	Angle
0.1	0.153	-163.3	2.48	164.8	0.211	3.8	0.17	-157.5
0.2	0.152	-169.2	2.47	163.9	0.211	3.3	0.17	-160.5
0.3	0.151	-175.7	2.46	162.4	0.211	2.8	0.18	163.4
0.4	0.150	177.3	2.44	160.4	0.212	2.3	0.18	-166.3
0.5	0.150	169.9	2.43	157.9	0.212	1.9	0.18	-169.5
0.6	0.152	165.0	2.42	154.6	0.213	1.8	0.19	-171.0
0.7	0.155	161.2	2.42	151.2	0.213	1.9	0.19	-172.3
0.8	0.159	158.3	2.42	147.7	0.213	2.1	0.20	-174.1
0.9	0.163	155.9	2.42	144.0	0.214	2.1	0.21	-176.1
1.0	0.166	154.1	2.42	140.3	0.215	2.3	0.22	-178.3
1.1	0.169	152.7	2.42	136.5	0.215	2.4	0.24	179.7
1.2	0.172	151.7	2.42	132.7	0.216	2.3	0.26	178.2
1.3	0.175	150.8	2.42	128.9	0.216	2.3	0.27	177.2
1.4	0.178	150.0	2.41	125.1	0.217	2.3	0.29	176.9
1.5	0.183	149.1	2.40	121.4	0.219	2.2	0.30	176.7
1.6	0.189	148.4	2.39	117.6	0.221	2.2	0.30	176.5
1.7	0.196	147.7	2.38	113.9	0.223	2.3	0.30	175.6
1.8	0.205	147.5	2.37	110.3	0.225	2.6	0.30	173.9
1.9	0.215	148.0	2.35	106.6	0.227	2.9	0.31	171.5
2.0	0.226	149.1	2.34	102.8	0.229	3.1	0.31	168.7
2.1	0.238	150.9	2.32	98.9	0.230	3.2	0.33	165.8
2.2	0.249	153.0	2.30	94.8	0.230	2.9	0.34	163.2
2.3	0.259	155.2	2.27	90.7	0.231	2.4	0.36	161.2
2.4	0.267	157.3	2.25	86.7	0.231	1.6	0.37	160.3
2.5	0.273	158.9	2.22	82.7	0.232	0.4	0.39	160.5
2.6	0.278	160.0	2.20	79.0	0.233	-0.8	0.40	161.4
2.7	0.286	160.7	2.17	75.5	0.236	-2.0	0.40	162.2
2.8	0.292	161.0	2.16	72.6	0.240	-3.3	0.40	163.1
2.9	0.297	161.1	2.14	70.3	0.244	-4.3	0.40	164.0
3.0	0.301	161.1	2.13	68.7	0.247	-4.9	0.40	164.7

Specification Subject to Change Without Notice